



4-254-827-11(1)

The player

USB Memory Player with FM Radio

Operating Instructions

pavit

AZ-BS1/BS32

©2004 Sony Corporation

WARNING

To prevent fire or shock hazard, do not expose the unit to rain or moisture.

Do not install the appliance in a confined space, such as a bookcase or built-in cabinet.

To prevent fire, do not cover the ventilation of the apparatus with news papers, table cloths, curtains, etc. And don't place lighted candles on the apparatus.

To prevent fire or shock hazard, do not place objects filled with liquids, such as vases, on the apparatus.

Certain countries may regulate disposal of the battery used to power this product. Please consult with your local authority.

The validity of the CE marking is restricted to only those countries where it is legally enforced, mainly in the countries EEA (European Economic Area).

For the customers in the USA Owner's Record

The model number is located at the rear and the serial number is located inside the battery compartment. Record the serial number in the space provided below. Refer to these numbers whenever you call upon your Aiwa dealer regarding this product.

Model No. _____
Serial No. _____

If you have any questions about this product, you may call;

Aiwa Customer Information Service Center
1-800-289-2492 or
<http://www.us.aiwa.com/>.

Declaration of Conformity

Trade Name: AIWA
Model No.: AZ-RM32
Responsible Party: Sony Electronics Inc.
Address: 16450 W. Bernardo Dr, San Diego, CA
92127 U.S.A.
Telephone No.: 858-942-2230

This device complies with part 15 of the FCC rules. Operation is subject to the following two conditions: (1) This device may not cause harmful interference, and (2) this device must accept any interference received, including interference that may cause undesired operation.

AZ-BS1: No "pavit"
AZ-BS32: AZ-RM32 (one 32-MB "pavit")

NOTE

This equipment has been tested and found to comply with the limits for a Class B digital device, pursuant to Part 15 of the FCC Rules. These limits are designed to provide reasonable protection against harmful interference in a residential installation. This equipment generates, uses, and can radiate radio frequency energy and, if not installed and used in accordance with the instructions, may cause harmful interference to radio communications. However, there is no guarantee that interference will not occur in a particular installation. If this equipment does cause harmful interference to radio or television reception, which can be determined by turning the equipment off and on, the user is encouraged to try to correct the interference by one or more of the following measures:

- Reorient or relocate the receiving antenna.
- Increase the separation between the equipment and receiver.
- Connect the equipment into an outlet on a circuit different from that to which the receiver is connected.
- Consult the dealer or an experienced radio/TV technician for help.

You are cautioned that any changes or modifications not expressly approved in this manual could void your authority to operate this equipment.

CAUTION

You are cautioned that any changes or modifications not expressly approved in this manual could void your authority to operate this equipment.

Table of Contents

Overview

What you can do with your player	4
Main features	5

Getting started

Step 1: Check the package contents.	6
Step 2: Insert batteries.	7
Locating controls	8

Basic operations

Listening to music	10
1. Insert the “pavit” into the player.	10
2. Start playback.	11

► Playback options

Playing a track repeatedly (REP1) / Playing all tracks in random order (SHUF).....	14
---	----

► Listening to the radio

Listening to the radio	15
Presetting radio stations	17

► Available features

Using the stopwatch	18
Using the countdown timer	19

► Changing the settings of the player

Changing the display pattern	20
Changing the backlight setting	20
Changing the display language	21

► Additional information

Precautions	22
Cleaning	22
Troubleshooting	23
Specifications	25
Index	26

Before using this player, install the application software on your computer using the supplied CD-ROM, and send some music data to the player.

What you can do with your player

AZ-BS1/BS32 is a USB memory player with FM radio specially designed for use with a USB storage media called “pavit.” You can send MP3 files on your computer to the “pavit,” insert the “pavit” into the player, and carry your favorite songs anywhere. In addition to playing music data (MP3), you can listen to FM broadcasts with this player.

1 Send your favorite songs to the “pavit.”

Use the supplied “Music Transfer pavit Edition” software to send MP3 files from your computer to the “pavit.”



2 Enjoy music anywhere with your player!



What is “pavit”?

The “pavit” is a compact, lightweight, new-generation USB storage media* with a large storage capacity. Although the “pavit” is dedicated to “pavit”-compatible devices, it can also be used as an external storage media for your computer, since it connects directly to the USB port, a standard interface for personal computers.

* Storage media is a device that can store data, such as floppy disk, hard disk and magneto-optic disk (MO).

The “pavit” complies with USB2.0 (High-Speed USB).

Main features

- Water-resistant construction allows you to use the player in the kitchen, bathroom or at the poolside.
- The player is equipped with an FM radio tuner. You can listen to FM broadcasts in addition to playing music data (MP3).
- MP3 files on your computer are sent to the “pavit” by simple and easy operations using the supplied “Music Transfer pavit Edition” software.
- The “pavit” connects directly to the USB port on your computer for high-speed data transfer.
- You can also store a variety of data other than MP3 files in the new-generation USB storage media “pavit.”
- You can stand the player on the table or hang it on a wall.

Notes

- Music you record is limited to private use only. Any other use requires the permission of the copyright holders.
- Sony is not liable for incomplete data transfer or damaged data due to problems of this product or your computer.

Getting started

Step 1: Check the package contents.

Check the accessories enclosed in the package.

- USB memory player with FM radio (1)
- USB storage media “pavit”* (1)

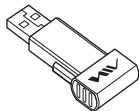
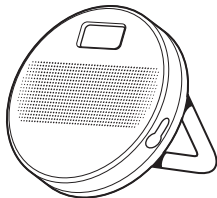

- CD-ROM (Music Transfer pavit Edition) (1)
- FM wire antenna (1)





- Operating instructions for the USB Memory Player with FM Radio (this manual)
- Operating instructions for the application software Music Transfer pavit Edition (1)
- Quick start guide (1)
- Strap (1)

* Supplied with AZ-BS32 only. For AZ-BS1, see “Optional accessories” on page 25.

Step 2: Insert batteries.

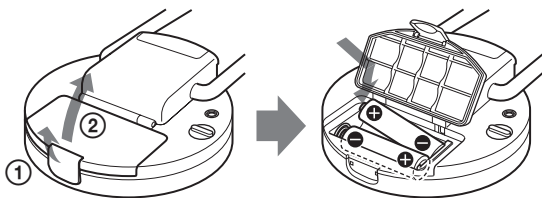
Insert two LR6 (size AA) alkaline batteries into the battery compartment as illustrated below.



Insert with the  side first.

Battery duration

Approximately 16 hours (continuous music data playback, with Sony LR6 (size AA) alkaline batteries)

When the batteries are drained, playback or radio reception stops and the power is turned off automatically. Operations of the buttons and switches may also become disabled. Even if you try to turn on the power in this state, nothing will be displayed and you cannot start playback. Also the volume of playback sound may be reduced when the battery level becomes low. Replace the batteries with new ones.

When you turn on the power after replacing the batteries, playback starts from the track whose playback was interrupted by battery drain.



When to change the batteries

The battery level indication in the display changes as follows:



Change the batteries when the battery level indication becomes “”

Notes

- The indicator sections of “” roughly show the remaining battery power. One section does not always indicate one-third of the battery power.
- Depending on the operating condition, the indicator sections of “” may increase or decrease.

Notes on dry batteries

- Do not throw batteries into fire.
- Do not carry batteries with coins or other metallic objects. It can generate heat if the positive and negative terminals of the battery are accidentally contacted by a metallic object.
- When the player is not to be used for a long time, remove the batteries.
- If battery leakage occurs, wipe off any deposit in the battery compartment, and insert new batteries. In case the deposit adheres to you, wash it off thoroughly.
- When the batteries are drained, remove the batteries from the player.

Locating controls

Player (front/top)

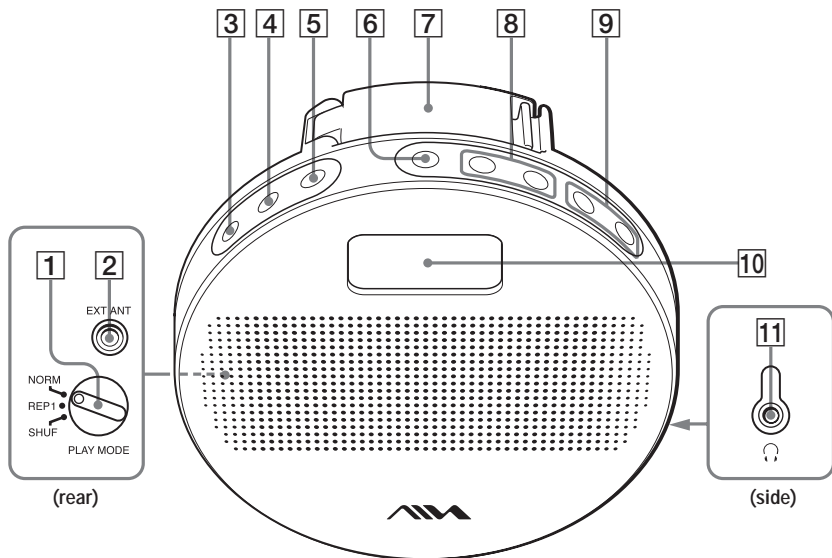

- 1 PLAY MODE switch (on the rear side)
- 2 EXT ANT socket for FM wire antenna (on the rear side)
- 3 MENU button
- 4 PRESET button
- 5 TUNER button
- 6 ►■ (PLAY/STOP)/POWER* button

- 7 "pavit" slot cover
- 8 ◀◀/▶▶ (SKIP/DOWN/UP) buttons
- 9 VOLUME -/+* buttons
- 10 Display
- 11 🎧 (headphones) jack (on the lateral side)

* The button has a tactile dot.

Display

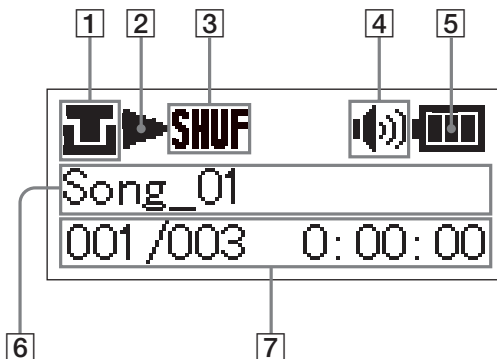

- 1** “pavit” insertion indicator
■: The “pavit” is inserted in the player correctly.
□: The “pavit” is not inserted in the player.
- 2** Operation status indication
Displays the icon for music data playback, radio, stopwatch or countdown timer.
- 3** Play mode indication
SHUF: Playing all tracks in random order
1: Playing a track repeatedly
“PRESET” is displayed in the radio preset mode.
- 4** Volume indication
Roughly shows the current volume level.
- 5** Battery level indication
Roughly shows the remaining power of the batteries. If “□” flashes, the batteries are depleted.
- 6** Character information display
Displays the title, file name of music data, etc.
During radio reception, displays the band and frequency.
- 7** Track number/elapsed playing time indication
Displays the preset numbers in the radio preset mode.

Listening to music

First, send MP3 files to the “pavit” from your computer using the supplied “Music Transfer pavit Edition” software. Refer to the separate manual “Music Transfer pavit Edition” about how to send MP3 files to the “pavit.”

1. Insert the “pavit” into the player.

Open the “pavit” slot cover and insert the “pavit” into the “pavit” slot.

When the power is turned on, the “pavit” insertion indicator “” will appear in the display.

If there are no music data in the “pavit,” the upper part of the “pavit” insertion indicator “” will flash.

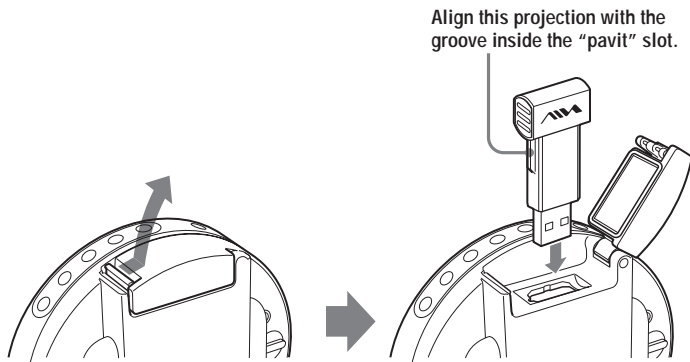

Note

Do not open the “pavit” slot cover for inserting/removing the “pavit” in places under high humidity such as in the bathroom or where water might splash on the player. Also, do not touch the “pavit” with wet hands.

2. Start playback.

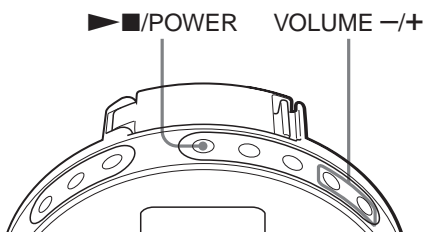

1 Press and hold ▶■/POWER.

The power is turned on, and playback starts.

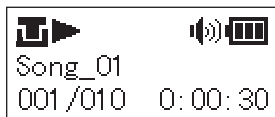

2 Press VOLUME -/+ to adjust the volume.

Music data (tracks) are played in the order of the Playlist you created using "Music Transfer pavit Edition."

During play mode, the track information* and elapsed playing time are displayed. Playback stops after the last track has been played.

* Displayed when the track has ID3 TAG information. If the track does not have ID3 TAG information, the file name is displayed. (ID3 TAG is a format to include textual information, such as title, album name and artist name, in MP3 files.)

(Continued)

Other operations

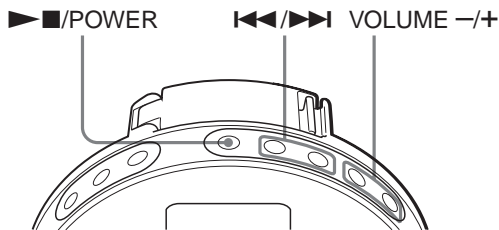

To	Do this
Go to the beginning of the next track	Press ▶▶. *1
Go to the beginning of the current track	Press ◀◀.
Go to the beginning of preceding tracks (track search)	Press ◀◀ repeatedly. *1 To quickly locate the desired track, press and hold ◀◀ until you find it. *2
Go to the beginning of succeeding tracks (track search)	Press ▶▶ repeatedly. *1 To quickly locate the desired track, press and hold ▶▶ until you find it. *2
Adjust the volume	Press VOLUME -/+. Press and hold VOLUME -/+ to quickly turn down or up the volume. *3
Stop playback	Press ▶■/POWER. *4
Turn off the power	Press and hold ▶■/POWER.

*1 Each time you press the button, playback proceeds to the next or previous track.

*2 When the first track is reached, playback of the first track starts.

*3 If you turn off the power with the volume set higher than a certain level, the volume will be lowered automatically next time you turn on the power, to prevent damage to your hearing. Adjust the volume to your desired level again.

*4 The power will be turned off automatically if the player is not operated for about 10 seconds while playback is stopped.

To remove the “pavit”

Always turn off the power before you remove the “pavit.” The music data or the “pavit” itself might be destructed if you remove the “pavit” with the player’s power turned on.

When removing the “pavit,” do not open the “pavit” slot cover in places under high humidity such as in the bathroom or where water might splash on the player. Also, do not touch the “pavit” with wet hands.

To start playback from the first track

Playback starts from the position where it was last stopped.

To start playback from the first track, press and hold **◀◀** or **▶▶** to return to the first track (page 12).

Playback will also start from the first track when:

- you remove the “pavit” and insert a different “pavit.”
- you reset the player (page 23).

To listen through headphones

Connect a pair of headphones to the  (headphones) jack.

When headphones are connected, sound is not output from the speakers.

Note

Do not use headphones in places under high humidity such as in the bathroom or where water might splash on the player. Also do not use the player with the rubber cap removed from the  (headphones) jack.

To hang the player

Unfold the handle of the player.

You can attach the supplied strap to the handle as illustrated below.

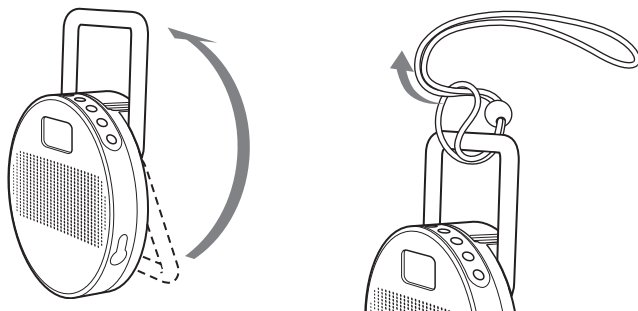

Note

Be careful not to drop the player when you hang it. Avoid hanging the player where the player sways and is liable to fall.

► Playback options

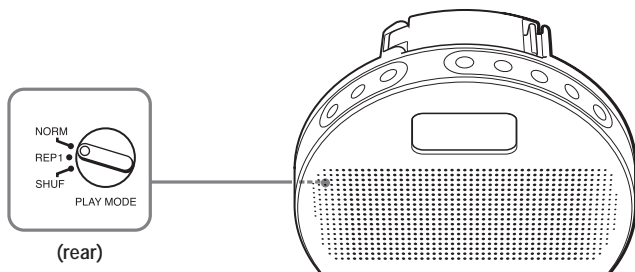

Playing a track repeatedly (**REP1**) / Playing all tracks in random order (**SHUF**)

To	Set the PLAY MODE switch to	Display
Play the current track repeatedly*1	REP1	RE1
Play all tracks in random order*2	SHUF	SHUF

*1 After the track has been played 10 times repeatedly, playback stops.

*2 Playback stops when all the tracks in the “pavit” have been played.

To return to normal play mode

Set the PLAY MODE switch to NORM.

▶ Listening to the radio

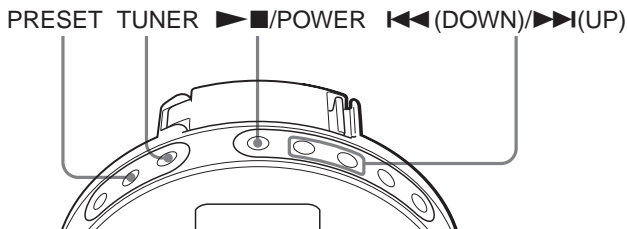

Listening to the radio

You can listen to FM broadcasts with and without inserting the “pavit” in the player.

1 Press and hold ▶■/POWER until the player is turned on.

If the radio was selected when you turned off the player last time, or if the “pavit” is not inserted in the player, the radio will be selected automatically when you turn on the player.

2 Press TUNER repeatedly to select “FM 1” or “FM 2.”

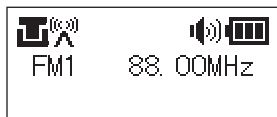

3 Press and hold I◀◀ (DOWN) or ▶▶I (UP) for about one second.

The player starts scanning the frequencies and stops when it finds a receivable station.

If you press I◀◀ (DOWN) or ▶▶I (UP) repeatedly, the frequency changes step by step.

To turn off the radio

Turn off the power by holding down ▶■/POWER until “SEE YOU” appears in the display.

If you press ▶■/POWER when the “pavit” is inserted in the player, music data will be played from the position where the playback was last stopped.

When the “pavit” is not inserted in the player, radio reception will continue if you press ▶■/POWER.

(Continued)

To enhance detection of receivable stations

If there are stations that you want preset but cannot do it automatically because their signals are not strong enough, change the setting of “AUTO STOP LEVEL” to “HIGH” in order to enhance detection of receivable stations.

- 1 Press MENU.
- 2 Press ◀◀ (DOWN) or ▶▶ (UP) repeatedly to select “AUTO STOP LEVEL.”
- 3 Press MENU.
- 4 Press ◀◀ (DOWN) or ▶▶ (UP) to select “HIGH.”

In case the same station is preset on two or more preset numbers because its signal is too strong, set the “AUTO STOP LEVEL” to “LOW.”

- 5 Press MENU.

* The default setting at the time of purchase is “MID.”

Note

Changing the setting of “AUTO STOP LEVEL” does not change the reception sensitivity.

To improve the reception

The player’s handle functions as the FM antenna. Change the position of the handle or the player itself to improve the reception.

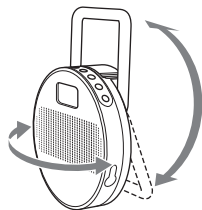

You can use the supplied FM wire antenna to gain extra sensitivity.

Attach the FM wire antenna by screwing it into the EXT ANT socket on the rear side of the player as shown below. Then, extend and position the FM wire antenna for the best reception.

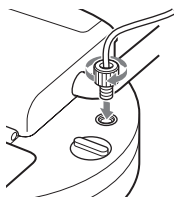

Presetting radio stations

You can preset up to 20 FM radio stations, 10 stations each for FM 1 and FM 2.

To preset stations automatically (Auto preset)

1 Perform steps 1 and 2 of “Listening to the radio” (page 15) to select the band.

2 Press PRESET.

“PRESET” and the preset numbers appear in the display.

3 Press and hold PRESET for more than 2 seconds.

“PRESET” starts flashing, and the player starts scanning for stations from the lower frequencies.



The first received station is preset on the preset number 1, and then the player starts scanning for the next receivable station.

If you press **▶■/POWER** or **TUNER** during auto presetting, the player stops scanning and exits the auto preset mode, and music data playback starts or the radio is switched to the other band.

To preset a station manually (Manual preset)

If there is a station that cannot be preset automatically, you can preset it manually by the following procedure.

Before starting, you must exit the auto preset mode (“PRESET” and the preset numbers should not be displayed).

- 1 Press **TUNER** repeatedly to select “FM 1” or “FM 2.”
- 2 Tune in the station you want to preset.
- 3 Press and hold **PRESET** for more than 2 seconds.
“PRESET” and the preset numbers flash in the display.
- 4 Within 10 seconds, press **◀◀** or **▶▶** repeatedly to select the preset number you want to store the station on.
The selected preset number starts flashing.
- 5 Within 10 seconds, press **PRESET**.

To tune in a preset station

1 Press TUNER repeatedly to select “FM 1” or “FM 2.”

2 Press PRESET to display the preset numbers.

3 Press ◀◀ or ▶▶ repeatedly to select the preset number of the station you want to tune in.

To clear all preset stations

Turn off the power, remove the “pavit” from the player, and press and hold **▶■/POWER** for more than 10 seconds.

The preset stations return to those at the time of purchase.

Using the stopwatch

You can use the player as a stopwatch. The stopwatch has a lap time feature enabling you to calculate a gap from a previous stored time.

You can use the stopwatch both while playing music data and listening to the radio.

1 During music data playback or radio reception, press MENU.

2 Press **I◀◀** or **▶▶I** repeatedly to select “STOPWATCH,” and then press MENU.

3 Press MENU.

Time count starts.

To stop the stopwatch

Press MENU.

To resume the time count, press MENU again.

To reset the stopwatch

After stopping the stopwatch by pressing MENU, press PRESET.

To display the lap time

Press PRESET at the point you need to check the lap time.

The current time is stored in the memory and the lap time (the time length from the previous stored time) is displayed.

The time count continues while “**LAP**” and the lap time are displayed.

To update the lap time, press PRESET again.

To exit the stopwatch mode

Press and hold MENU for more than 2 seconds.





The icon for stopwatch “” changes to that for music data playback or radio.

Tip

The stopwatch can count up to 99 minutes 59 seconds 99 centiseconds. To continue the time count from then on, you need to reset the stopwatch.

Using the countdown timer

The alarm can be set to go off after the specified time period has passed. You can specify the time by the minute, from 1 to 99 minutes.

-
- 1 During music data playback or radio reception, press MENU.**
 - 2 Press  or  repeatedly to select "COUNTDOWN," and then press MENU.**
 - 3 Press  or  repeatedly to specify the time length (1 to 99 minutes) until the alarm goes off, and then press MENU.**

Countdown starts.

"" is displayed during countdown.

When the time reaches zero, music data playback or radio reception is interrupted and the alarm sounds for one minute in the headphones.

Then, after the alarm stops, the display returns to the previous screen and music data playback or radio reception continues.

To turn off the alarm

Press any button on the player.

To cancel the countdown timer

Press and hold MENU for more than 2 seconds.

"" disappears.

Changing the display pattern

You can select from the following three display patterns:

Setting	Display
Title	Track name
Title+Artist	Track name and artist name
Title+Album	Track name and album name

Title, artist name and album name are displayed when the track has ID3 TAG information. If the track does not have ID3 TAG information, the file name is displayed.

- 1 During music data playback or radio reception, press MENU.**
- 2 Press I◀◀ or ▶▶I repeatedly to select “DISPLAY,” and then press MENU.**
- 3 Press I◀◀ or ▶▶I to select the display pattern you want, and then press MENU.**

To return to the menu screen

Select “BACK” in step 3.

Changing the backlight setting

You can change the lighting time of the backlight for the display.

- 1 During music data playback or radio reception, press MENU.**
- 2 Press I◀◀ or ▶▶I repeatedly to select “BACKLIGHT,” and then press MENU.**
- 3 Press I◀◀ or ▶▶I repeatedly to specify the lighting time (5, 10, 15 or 20 seconds) of the backlight, and then press MENU.**

To return to the menu screen

Select “BACK” in step 3.

If you do not want to turn on the backlight

Select “OFF” in step 3.

Depending on the surrounding light, the visibility of the display may improve if you turn off the backlight.

Note

Regardless of the BACKLIGHT setting, the backlight turns off when the battery level indication becomes “.

Changing the display language

You can select the language to be used for displaying the menu from:

Japanese, English, German, French, Italian and Spanish.

- 1** During music data playback or radio reception, press **MENU**.
 - 2** Press **◀◀** or **▶▶** repeatedly to select “LANGUAGE,” and then press **MENU**.
 - 3** Press **◀◀** or **▶▶** repeatedly to select the language, and then press **MENU**.
-

To return to the menu screen

Select “BACK” in step 3.

Note

The ID3 TAG text will not change into a different language by this operation.

Precautions

General

Never place the player in a place:

- under direct sunlight or near heat sources
- in a car with its windows closed (especially in summer)
- where there is much dust
- near magnets or magnetized items such as speakers or a TV

On the water-resistant construction

Since this player is water resistant, you can use it in the bathroom by observing the following precautions:

- Do not allow the player to come in contact with large amounts of water.
- Do not immerse the player in water.
- Do not touch the player with soapy, wet hands.
- Do not dry the player with a hair dryer.
- In case water gets inside the speakers, turn the player upside down to drain water.
- Do not open the battery compartment or “pavit” slot cover with wet hands. Drain and wipe off any water with a dry cloth before opening the battery compartment or “pavit” slot cover.
- Do not open the “pavit” slot cover for inserting/removing the “pavit” in places under high humidity such as in the bathroom or where water might splash on the player.
- Do not use headphones in places under high humidity such as in the bathroom or where water might splash on the player. Also do not use the player with the rubber cap removed from the  (headphones) jack.
- Our warranty does not apply to failures or malfunctions of the product caused by water intrusion. In such a case, we will repair the product at your expense.

In case of failure of this player, consult your Aiwa dealer without opening the casing. If failure occurs while the “pavit” is inserted in the player, it is recommended not to remove the “pavit” from the player to ensure an early solution to the problem.

Cleaning

Clean your player’s casing with a soft cloth slightly moistened with water or a mild detergent solution.

Note

Do not use any type of abrasive pad, scouring powder or solvent such as alcohol or benzene as it may mar the finish of the casing.

If you have any questions or problems concerning your player, please consult your nearest Aiwa dealer.

Troubleshooting

If you experience any of the following difficulties while using your player, use this troubleshooting guide to help you to remedy the problem. Should any problem persist, consult your nearest Aiwa dealer.

For trouble concerning operations while connected to your computer, also refer to "Troubleshooting" in the separate manual "Music Transfer pavit Edition."

Operation

Symptom	Cause/Remedy
There is no sound.	<ul style="list-style-type: none">→ The volume level is set to the minimum level. Increase the volume (page 11).→ The "pavit" is not inserted in the player correctly. Reinsert the "pavit" and check if the "pavit" insertion indicator "■" is displayed (page 10).
The display becomes hard to see or nothing is displayed.	<ul style="list-style-type: none">→ The player contains moisture condensation. Let your player sit for a few hours at room temperature.→ The batteries are exhausted. Replace the batteries with new ones (page 7).
The sound is distorted.	<ul style="list-style-type: none">→ The bit rate used when encoding the MP3 files was low. Send MP3 files encoded with higher bit rates to the "pavit."
Playback stops suddenly or the volume is reduced.	<ul style="list-style-type: none">→ The batteries are exhausted. Replace the batteries with new ones (page 7).
There is noise in the playback sound.	<ul style="list-style-type: none">→ The music data itself contains noise. Noise may have been introduced when creating music data due to the conditions of the computer. Create the music data again.
Erroneous display.	<ul style="list-style-type: none">→ The player is not functioning normally. Remove the "pavit" from the player, and then press and hold /POWER for more than 10 seconds to reset the player.→ Send the music data to the "pavit" again, as the data stored in the "pavit" may have been destructed.
The upper part of the "pavit" insertion indicator "■" flashes.	<ul style="list-style-type: none">→ The "pavit" does not have any music data, or the music data stored in the "pavit" may be destructed. Send the music data to the "pavit" again.

(Continued)

Battery

Symptom	Cause/Remedy
Battery life is short.	→ The operating temperature is below 0°C (32°F). Battery life becomes shorter in cold temperatures due to battery characteristics. This is not a malfunction.

Radio

Symptom	Cause/Remedy
The audio is weak or contains noise.	→ The batteries are exhausted. Replace the batteries with new ones (page 7). → Move the player away from electric products (TV, cellular phone, etc). → The player is being used where radio signal is weak. Change the position of the handle or the player itself. It is recommended to attach the supplied FM wire antenna to the player.
The player tunes in to a station with much noise or where there is no station.	→ Set the "AUTO STOP LEVEL" to "LOW" (page 16).

Other

Symptom	Cause/Remedy
The "pavit" cannot be inserted into the player.	→ The "pavit" is being inserted backwards. Insert the "pavit" in the correct orientation.
The player gets warm.	→ The player gets warm if it is used for an extended period of time. This is not a malfunction.
The "pavit" which has been used on another device does not work.	→ The "pavit" has been formatted on a computer or other device. Make a backup copy of any important data in the "pavit," such as by copying it to the hard disk of your computer. Then reformat the "pavit," using the supplied Music Transfer pavit Edition software. As Music Transfer pavit Edition is not compatible with FAT32 file systems, reformat the "pavit" with FAT or FAT16 format.

Specifications

USB memory player

Supported audio file format

MP3 Bit rate: 8 - 320 kbps*

Sampling frequencies: 24/22.05/16/12/
11.025/8/32/44.1/48 kHz

* 128 kbps or higher bit rate is recommended.

Frequency response

20 - 20,000 Hz (single signal measurement)

Radio

Frequency range

FM 1/FM 2: 87.5 - 108.0 MHz

Antenna

FM antenna built in the player's handle

FM wire antenna supplied with the player

General

Speakers

3.6 cm (1 ⁷/₁₆ in.) diameter, cone type, 4 Ω × 2

Output

Headphones: Stereo mini-jack

Maximum power output

160 mW + 160 mW (SPEAKER OUTPUT)

Operating temperature

5°C - 35°C (41°F - 95°F)

Power source

3 V DC, LR6 (size AA) alkaline batteries × 2

Battery life*

Music data playback: Approx. 16 hours

Radio reception: Approx. 16 hours

* When using two Sony LR6 (size AA) alkaline
batteries

Dimensions

Approx. 115 × 115 × 39.3 mm

(4 ⁵/₈ × 4 ⁵/₈ × 1 ⁹/₁₆ in.)

(w/h/d, excluding projecting parts)

Approx. 115 × 115.2 × 39.3 mm

(4 ⁵/₈ × 4 ⁵/₈ × 1 ⁹/₁₆ in.)

(w/h/d, including projecting parts)

Mass

Approx. 193 g (6.8 oz) (including the "pavit")

Accessories

See page 6.

Optional accessories

USB storage media "pavit"

AZ-RM128P: 128 MB

AZ-RM256P: 256 MB

Design and specifications are subject to change
without notice.

Index

A, B

Backlight 20

Battery 7

C

Cleaning 22

Countdown timer 19

D, E

Display 9, 20

F, G

Format 24

H, I, J, K

Headphones 13

L

Listening to music 10

M, N, O

MP3 4, 5

P, Q

“pavit” 4, 5

insert 10

remove 12

Preset 17

R

Radio 15

Repeat 14

Reset 23

S

SHUF (Shuffle) 14

Stopwatch 18

T, U

Troubleshooting 23

V, W, X, Y, Z

Volume 11, 12

<http://www.aiwa.com/>

Sony Corporation Printed in Korea

For the customers in the USA

For assistance and information

visit us on the internet at

www.us.aiwa.com

call toll free 1-800-BUY-AIWA
(United States only)